

5050 Product



KRAMER
on the safe side



Lighter. Stronger. Higher

Kramer will exhibit a special innovation with the wheel loader 5050, which is characterised by its very low dead weight of 2,620 kg and a tipping load of up to 1,700 kg. Due to the nature of the machine and the easy and lower priced transport possibility, the wheel loader can be used by gardening and landscaping contractors.

- High stack tipping load with Smart Ballast of 1,700 kg: Problem-free and safe transport of stone pallets possible
- Easy trailer transport due to low weight: Because without Smart Ballast the machine weighs just 2,620 kg
- The Smart Ballast weights in total weigh 100 kg. Each of the eight weights weighs a portable 12.5 kg
- Of course, the 5050 also impresses with its constant payload and the undivided frame
- Environmentally friendly engine technology: 35 kW engine with exhaust emission level V, as well as DOC and DPF

5050 Technical specifications

Operating data

Bucket capacity	0.45 m ³
Operating weight with Smart Ballast	2,645 kg

Engine / Motor

Engine / Motor manufacturer	Yanmar
Engine performance	35 kW
Emission standards stage (standard)	V

Power transmission

Traction drive	Automotive continuously variable, hydrostatic axial piston drive
Travel speed	20 km/h
Travel speed Option	30 km/h
Standard tires	10.5- 18 - Universal profile
Differential lock Option	100 % connectable - front axle
Max. steering angle	2 x 38 °

Steering and operating hydraulics

Max. pump discharge capacity	56 l/min
Max. pump pressure	235 bar

Kinematics

Design system	P-kinematics
Tipping load without Smart Ballast (pallet forks)	1,500 kg
Tipping load with Smart Ballast (pallet forks)	1,700 kg
Payload (standard bucket)	1,200 kg
Payload mit Smart Ballast S=1,25	1,360 kg

Filling capacities

Fuel tank	60 l
Hydraulic oil tank	58 l

Sound emission

Measured value	100 dB(A)
Guaranteed value	101 dB(A)
Noise level at the driver's ear	79 dB(A)

Vibrations

Total vibrations value of the upper body extremities	< 2.5 m/s ²
Highest effective value of weighted acceleration for the body	< 0.5

5050 Dimensions

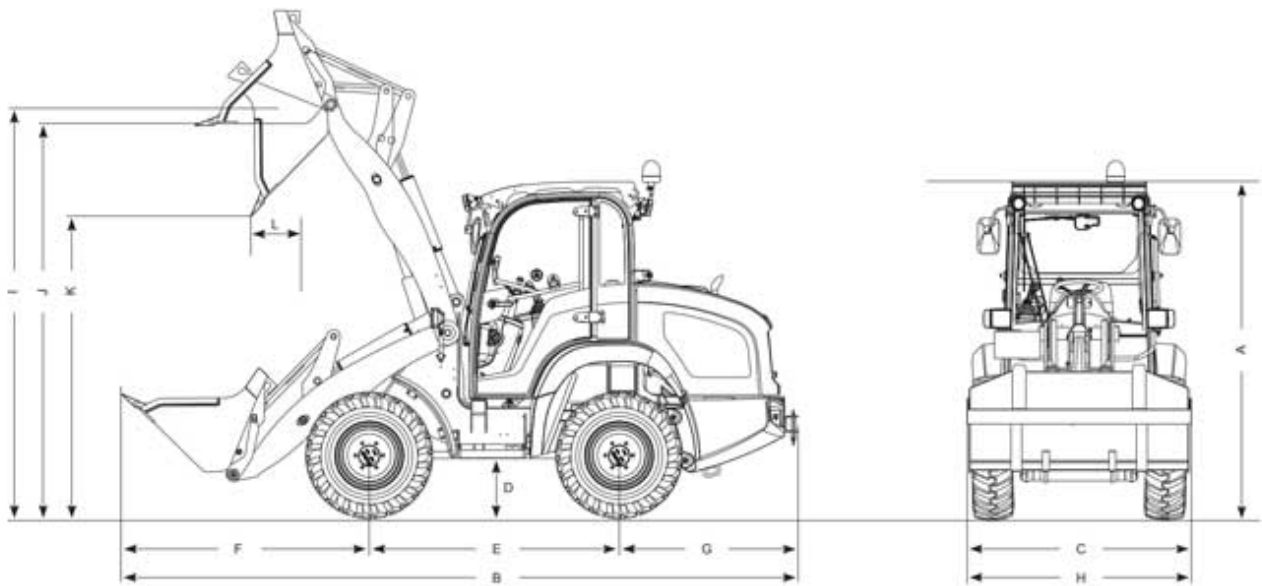

A	Height	2,390 mm
B	Length	4,790 mm
C	Width	1,650 mm
	Overall width	1,650 mm
E	Wheelbase	1,850 mm

Please note: that product availability can vary from country to country. It is possible that information / products may not be available in your country. More detailed information on engine power can be found in the operator's manual; the stated power may vary due to specific operating conditions. Subject to alterations and errors excepted. Applicable also to illustrations.
 Copyright © 2022 Kramer-Werke GmbH.